

**ALL IN 1**

# **JOB PLACEMENT CARD**

3 easy steps to repeating your orders

Type of Garment: KNIT SPORT SHIRT - T-SHIRT - SWEATSHIRT

Embroidery Location: LEFT OR RIGHT CHEST PLACEMENT

Garment Size: Youth XSM Adult         

Board Size Used: Sleeve - Infant - Youth - Adults - XL Adults

**ALL IN 1  
Leveler  
Pro**



Adult Board  
With Extension  
arms out

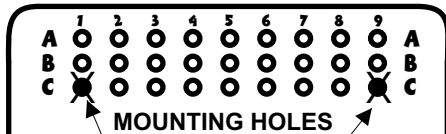

**Step#1**  
WHICH HOLE  
TO USE

- 4.7" ⊕ 12cm
- 5.9" ⊕ 15cm**
- 7.1" ⊕ 18cm
- 8.3" ⊕ 21cm

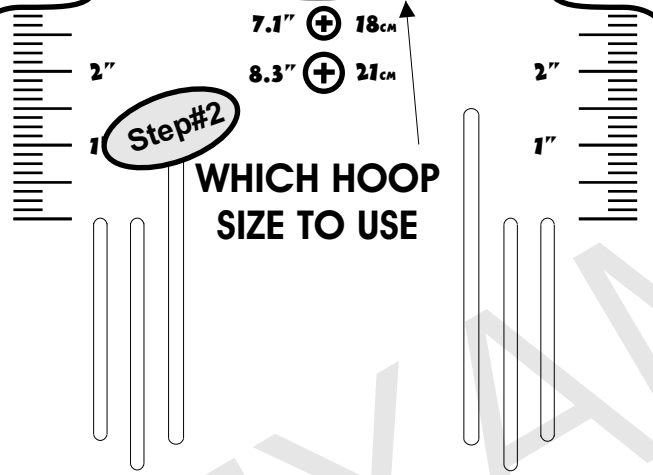

**Step#2**  
WHICH HOOP  
SIZE TO USE

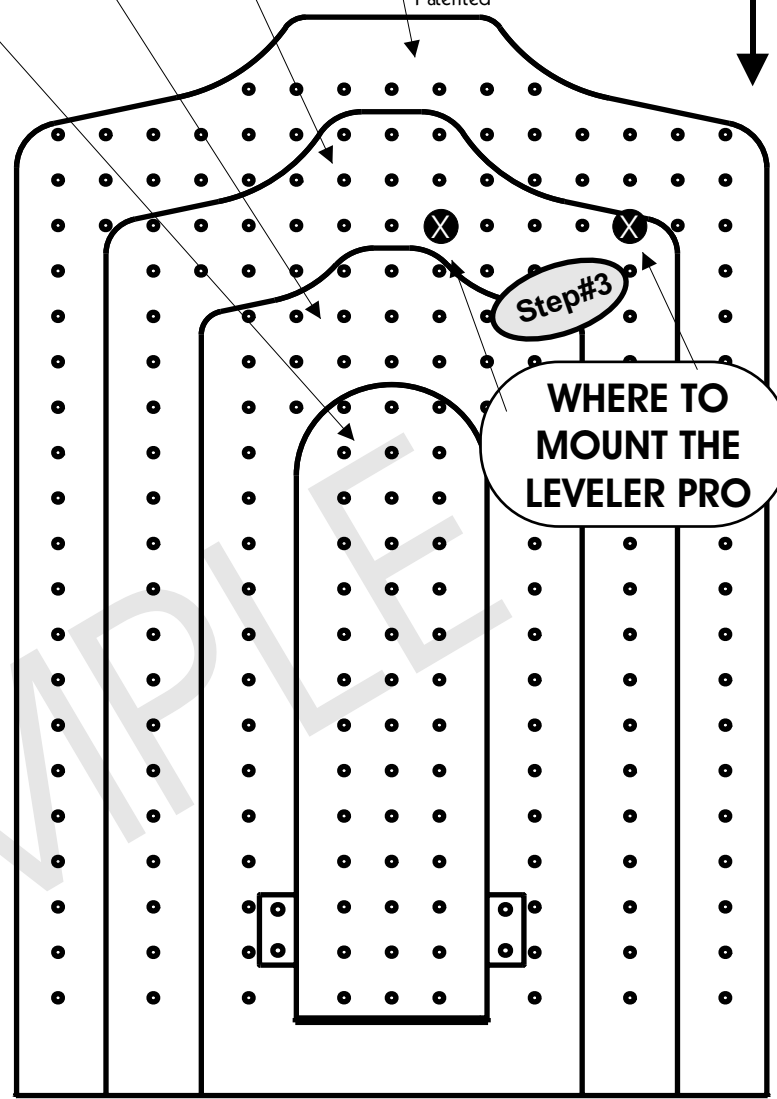

**WHERE TO  
MOUNT THE  
LEVELER PRO**

visit [tex-inc.com](http://tex-inc.com) for **FREE** Designs & **FREE** Digitizing Quote!

**YOUTH**

# **JOB PLACEMENT CARD**

3 easy steps to repeating your orders

Type of Garment: KNIT SPORT SHIRT - T-SHIRT - SWEATSHIRT

Embroidery Location: LEFT OR RIGHT CHEST PLACEMENT

Garment Size: Youth XSM Adult

Board Size Used: Sleeve - Infant - Youth - Adults - XL Adults

**ALL IN 1  
Leveler  
Pro**

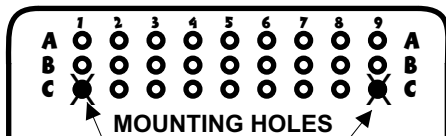

**Step#1**  
WHICH HOLE TO USE

- 4.7" 12cm
- 5.9" 15cm**
- 7.1" 18cm
- 8.3" 21cm

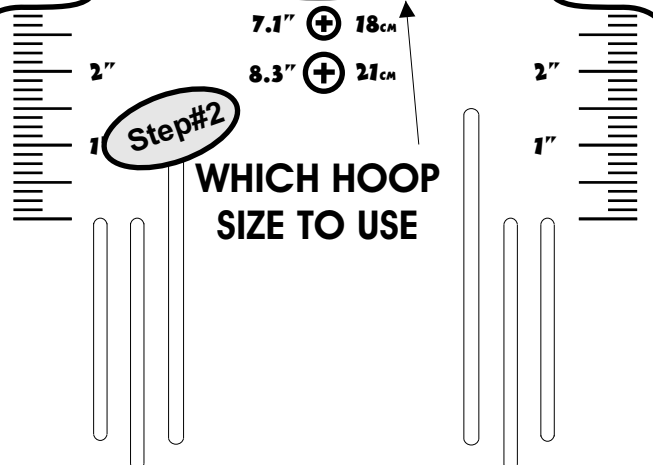

**Step#2**  
WHICH HOOP SIZE TO USE

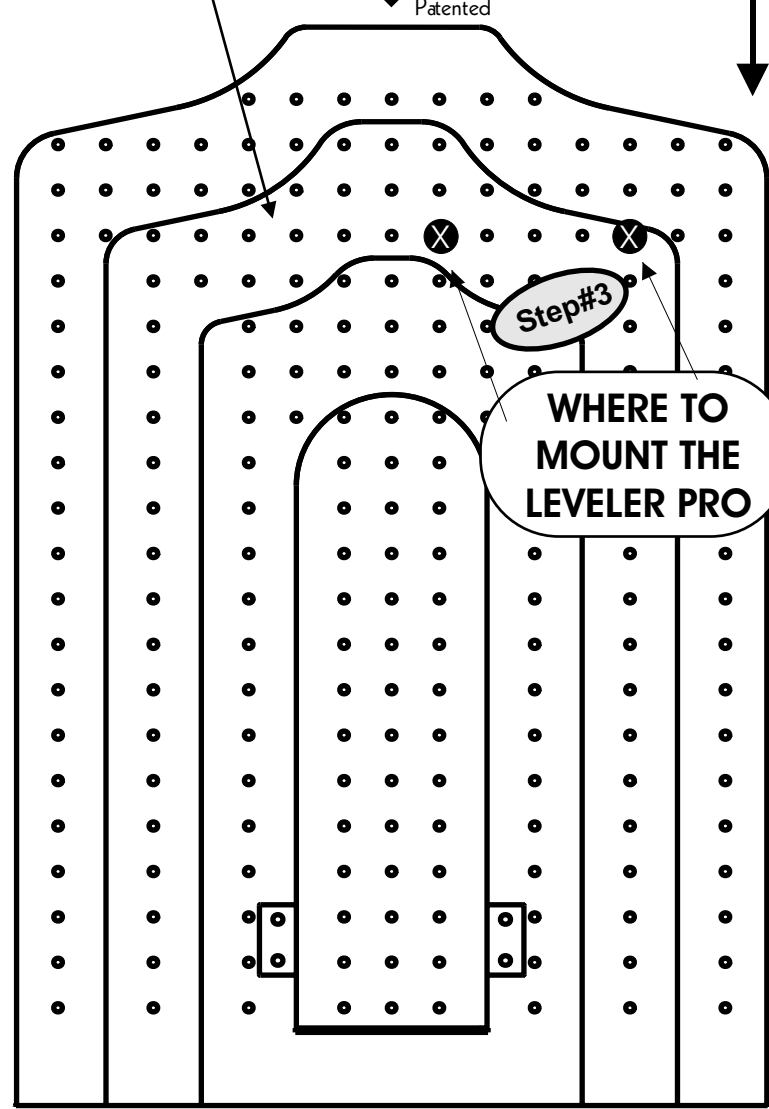

**Step#3**  
WHERE TO MOUNT THE LEVELER PRO

visit [tex-inc.com](http://tex-inc.com) for **FREE** Designs & **FREE** Digitizing Quote!

**YOUTH**

# **JOB PLACEMENT CARD**

3 easy steps to repeating your orders

Type of Garment: KNIT SPORT SHIRT - T-SHIRT - SWEATSHIRT

Embroidery Location: LEFT OR RIGHT CHEST PLACEMENT

Garment Size: Youth SM-MED Adult

Board Size Used: Sleeve - Infant - Youth - Adults - XL Adults

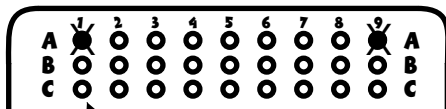

MOUNTING HOLES

**Step#1**  
WHICH HOLE TO USE

- 4.7" 12cm
- 5.9" 15cm**
- 7.1" 18cm
- 8.3" 21cm

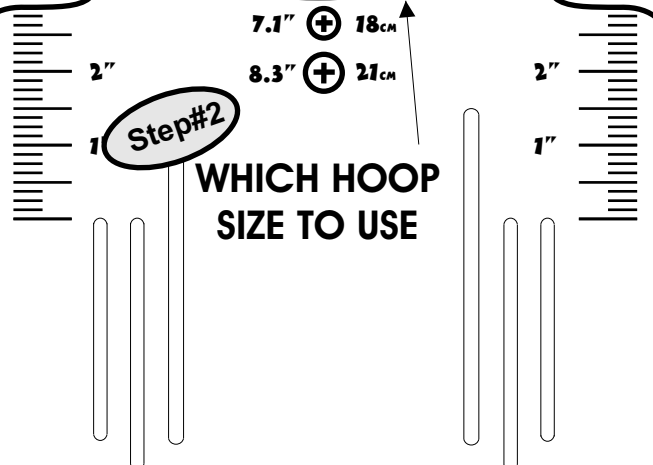

**Step#2**  
WHICH HOOP SIZE TO USE

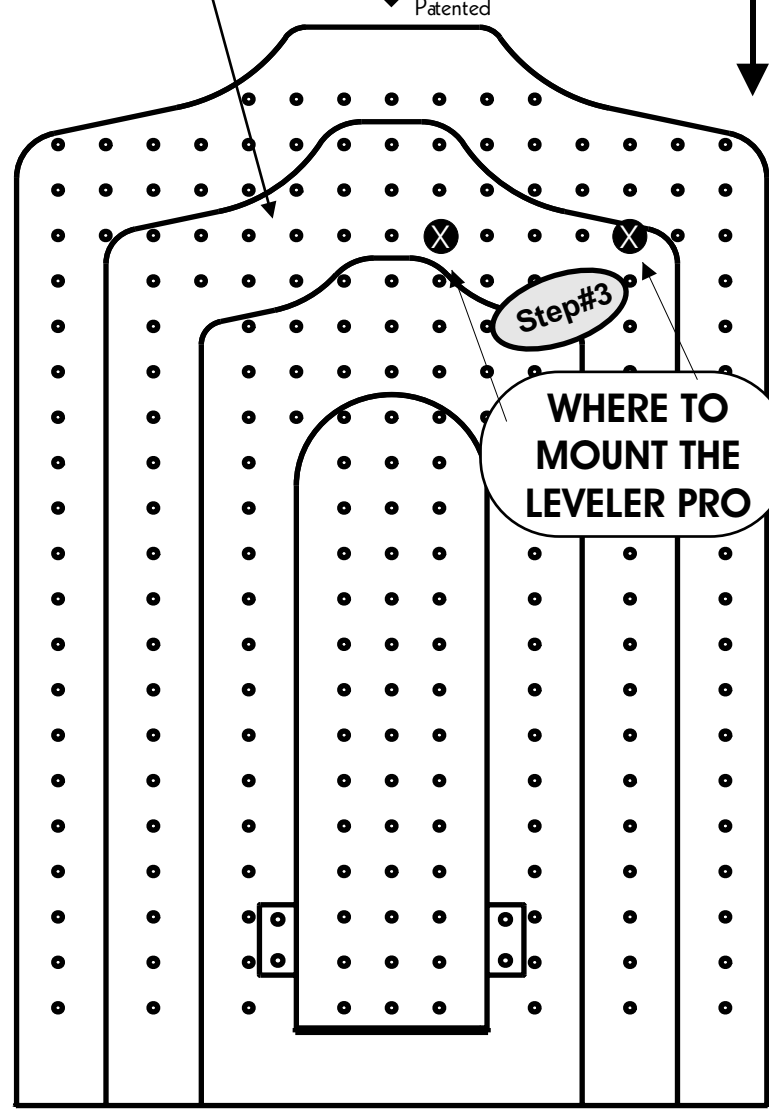

**Step#3**  
WHERE TO MOUNT THE LEVELER PRO

visit [tex-inc.com](http://tex-inc.com) for **FREE** Designs & **FREE** Digitizing Quote!

**YOUTH**

# **JOB PLACEMENT CARD**

3 easy steps to repeating your orders

Type of Garment: HOODED SWEATS / 3/4" RAGLAN T-SHIRT

Embroidery Location: LEFT OR RIGHT CHEST PLACEMENT

Garment Size: Youth SM-MED Adult

Board Size Used: Sleeve - Infant - Youth - Adults - XL Adults

**ALL IN 1  
Leveler  
Pro**

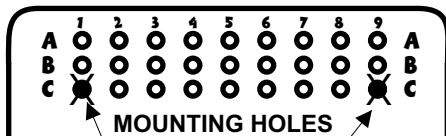

**Step#1**  
WHICH HOLE TO USE

- 4.7" ⊕ 12cm
- 5.9" ⊕ 15cm**
- 7.1" ⊕ 18cm
- 8.3" ⊕ 21cm

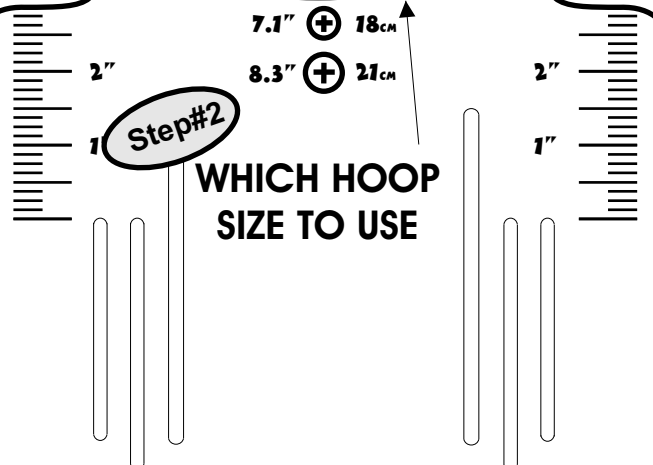

**Step#2**  
WHICH HOOP SIZE TO USE

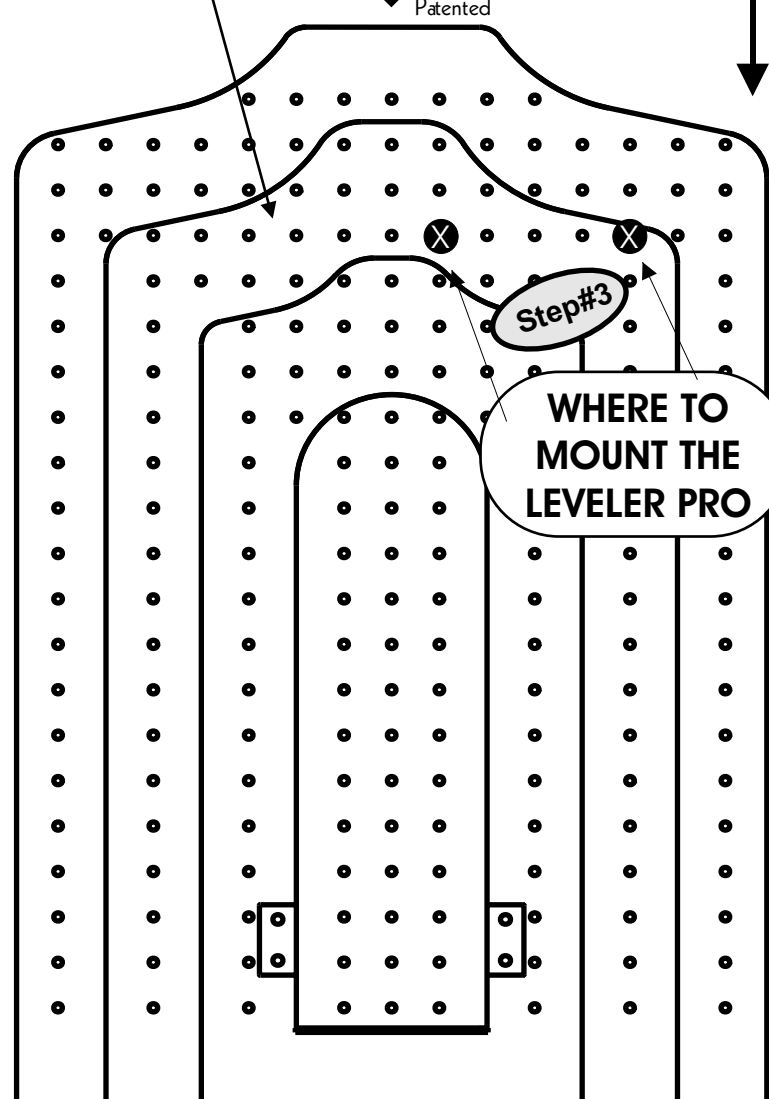

**Step#3**  
WHERE TO MOUNT THE LEVELER PRO

visit [tex-inc.com](http://tex-inc.com) for **FREE** Designs & **FREE** Digitizing Quote!

**YOUTH**

# **JOB PLACEMENT CARD**

3 easy steps to repeating your orders

Type of Garment: KNIT SPORT SHIRT - T-SHIRT - SWEATSHIRT

Embroidery Location: LEFT OR RIGHT CHEST PLACEMENT

Garment Size: Youth SM-MED Adult

Board Size Used: Sleeve - Infant - Youth - Adults - XL Adults

**ALL IN 1  
Leveler  
Pro**

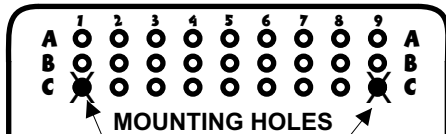

**Step#1**  
WHICH HOLE TO USE

- 4.7" 12cm
- 5.9" 15cm**
- 7.1" 18cm
- 8.3" 21cm

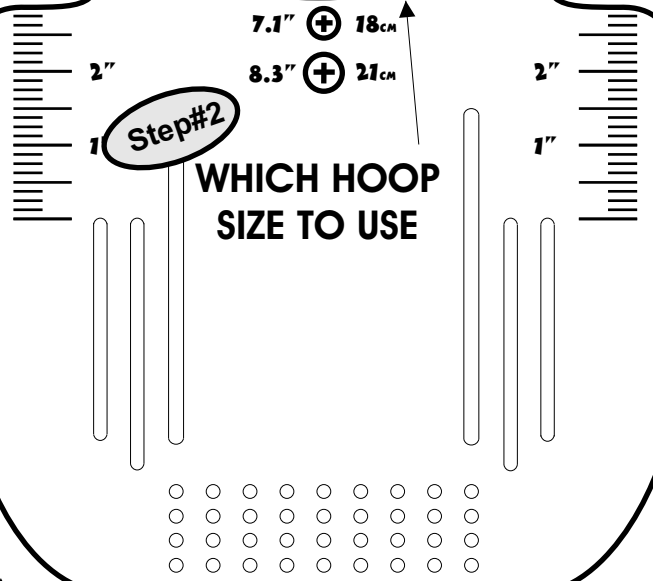

**Step#2**  
WHICH HOOP SIZE TO USE

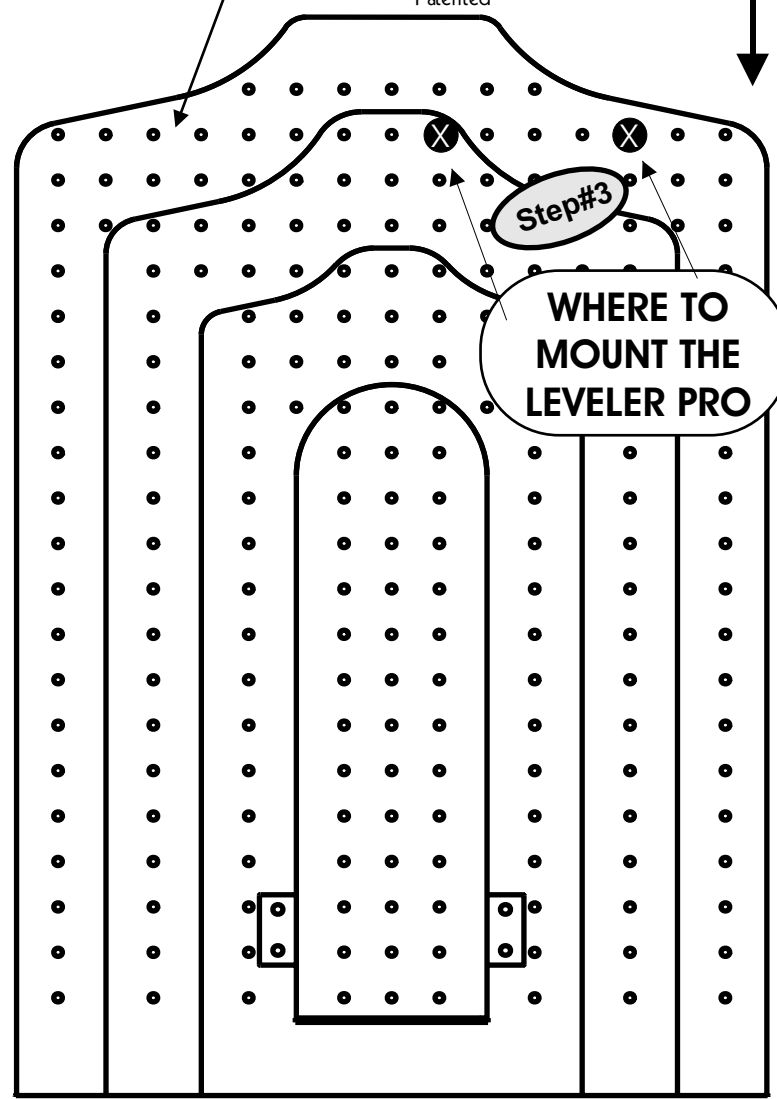

visit [tex-inc.com](http://tex-inc.com) for **FREE** Designs & **FREE** Digitizing Quote!

**YOUTH**

# **JOB PLACEMENT CARD**

3 easy steps to repeating your orders

Type of Garment: KNIT SPORT SHIRT - T-SHIRT - SWEATSHIRT

Embroidery Location: LEFT OR RIGHT CHEST PLACEMENT

Garment Size: Youth LG-XLG Adult

Board Size Used: Sleeve - Infant - Youth - Adults - XL Adults

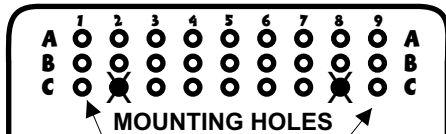

**Step#1**  
WHICH HOLE TO USE

- 4.7" ⊕ 12cm
- 5.9" ⊕ 15cm**
- 7.1" ⊕ 18cm
- 8.3" ⊕ 21cm

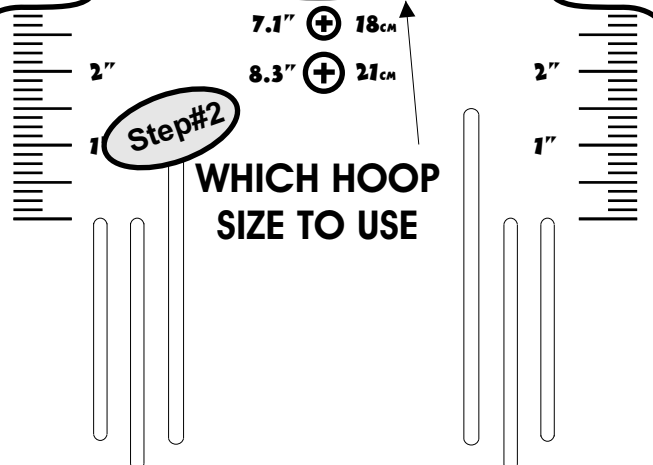

**Step#2**  
WHICH HOOP SIZE TO USE

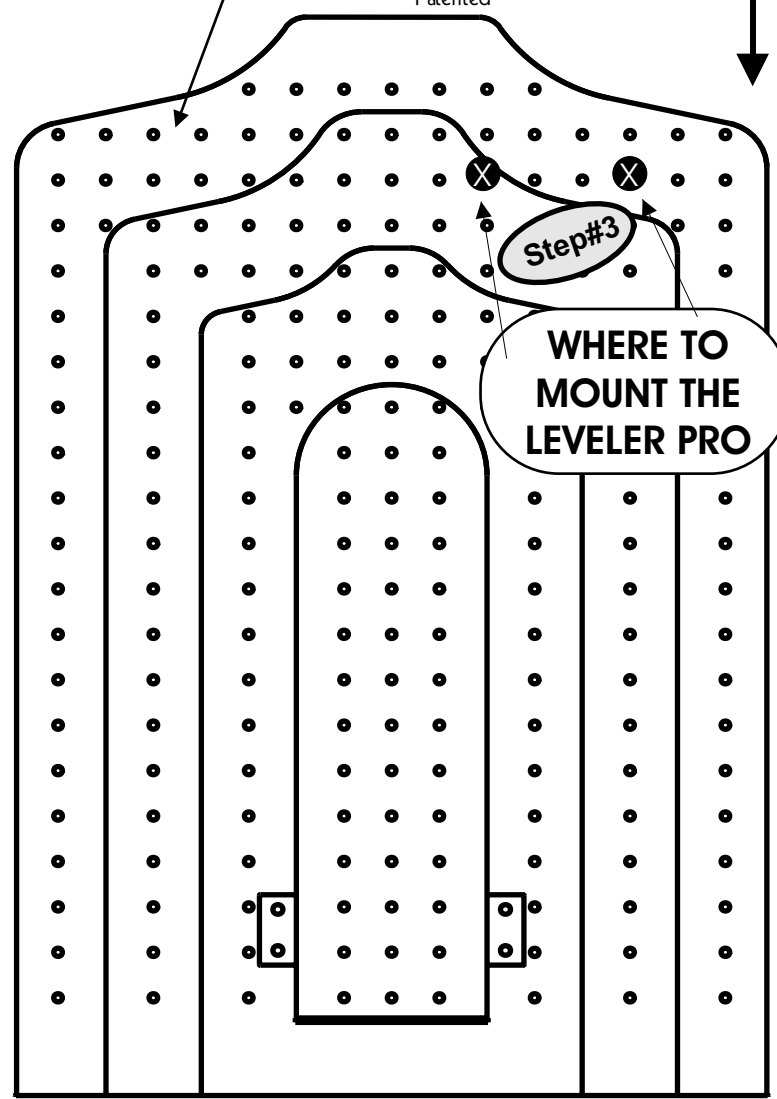

visit [tex-inc.com](http://tex-inc.com) for **FREE** Designs & **FREE** Digitizing Quote!

**ADULT**

# **JOB PLACEMENT CARD**

3 easy steps to repeating your orders

Type of Garment: KNIT SPORT SHIRT - T-SHIRT - SWEATSHIRT

Embroidery Location: LEFT OR RIGHT CHEST PLACEMENT

Garment Size: Youth Adult SM-MED

Board Size Used: Sleeve - Infant - Youth - Adults - XL Adults

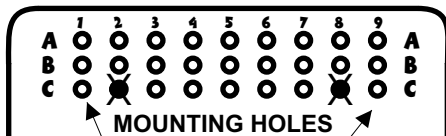

**Step#1**  
WHICH HOLE TO USE

- 4.7" ⊕ 12cm
- 5.9" ⊕ 15cm**
- 7.1" ⊕ 18cm
- 8.3" ⊕ 21cm

**Step#2**  
WHICH HOOP SIZE TO USE

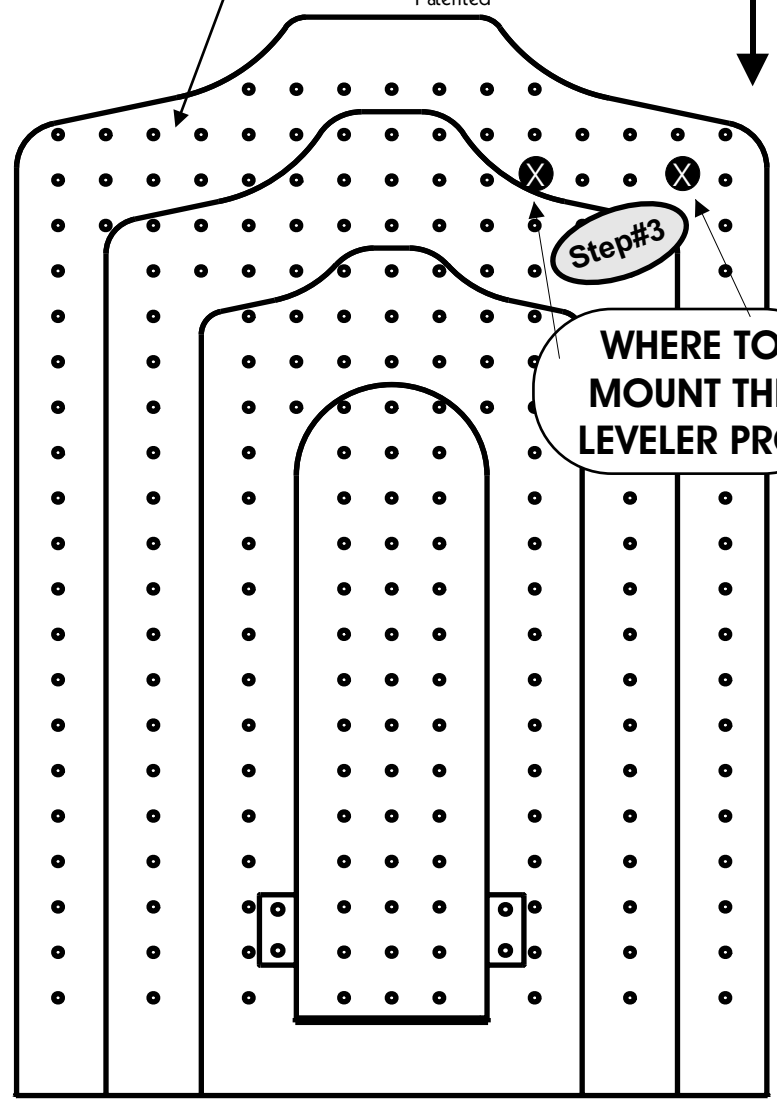
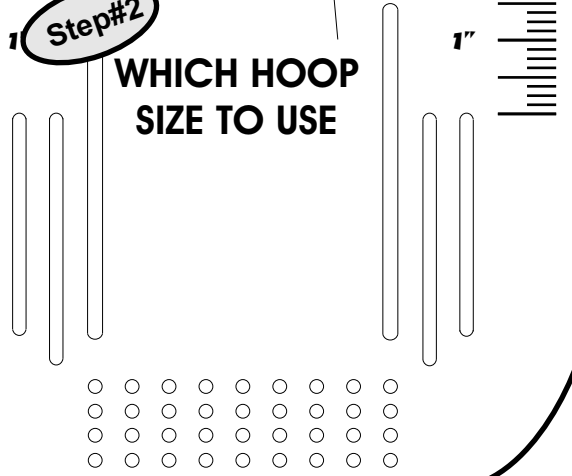

**Step#3**  
WHERE TO MOUNT THE LEVELER PRO

visit [tex-inc.com](http://tex-inc.com) for **FREE** Designs & **FREE** Digitizing Quote!

**ADULT**

# **JOB PLACEMENT CARD**

3 easy steps to repeating your orders

Type of Garment: KNIT SPORT SHIRT - T-SHIRT - SWEATSHIRT

Embroidery Location: LEFT OR RIGHT CHEST PLACEMENT

Garment Size: Youth Adult LG-XLG

Board Size Used: Sleeve - Infant - Youth - Adults - XL Adults

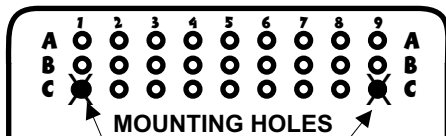

**Step#1**  
WHICH HOLE TO USE

- 4.7" 12cm
- 5.9" 15cm**
- 7.1" 18cm
- 8.3" 21cm

**Step#2**  
WHICH HOOP SIZE TO USE

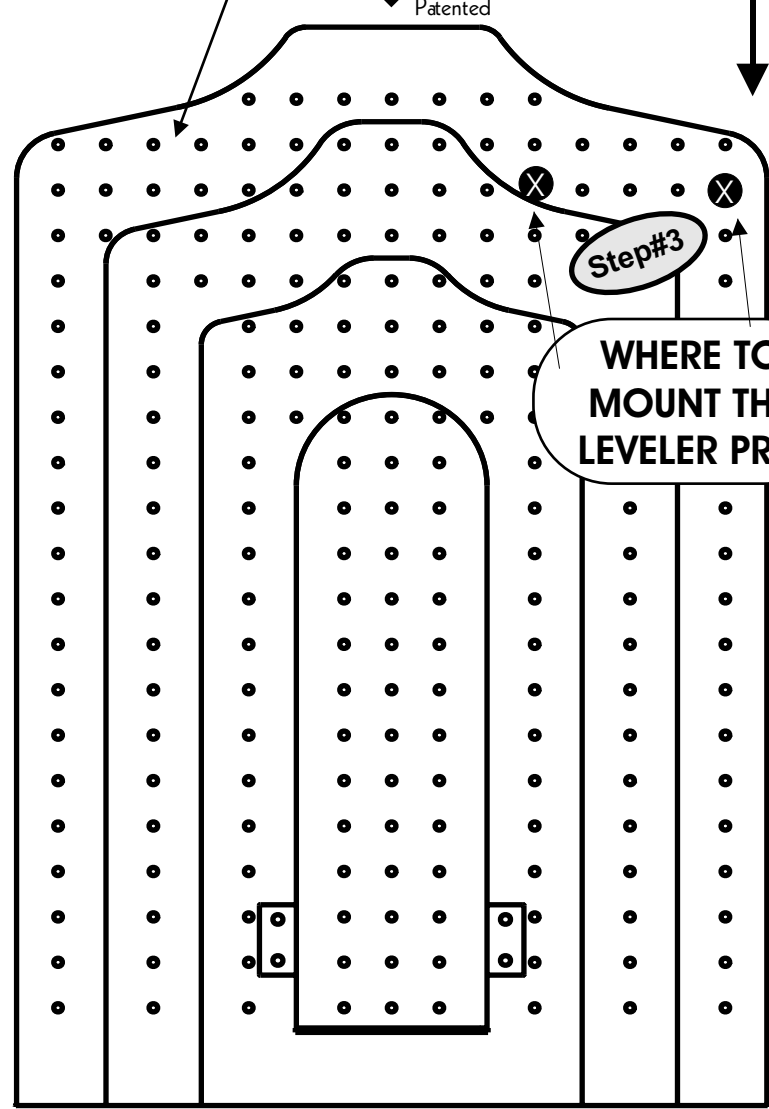

**Step#3**  
WHERE TO MOUNT THE LEVELER PRO

visit [tex-inc.com](http://tex-inc.com) for **FREE** Designs & **FREE** Digitizing Quote!

**ADULT**

# **JOB PLACEMENT CARD**

3 easy steps to repeating your orders

Type of Garment: KNIT SPORT SHIRT - T-SHIRT - SWEATSHIRT

Embroidery Location: LEFT OR RIGHT CHEST PLACEMENT

Garment Size: Youth Adult 2XLG & UP

Board Size Used: Sleeve - Infant - Youth - Adults - XL Adults



Adult Board  
With Extension  
arms out

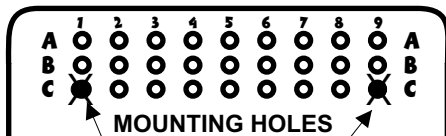

**Step#1**  
WHICH HOLE  
TO USE

- 4.7" 12cm
- 5.9" 15cm**
- 7.1" 18cm
- 8.3" 21cm

**Step#2**  
WHICH HOOP  
SIZE TO USE

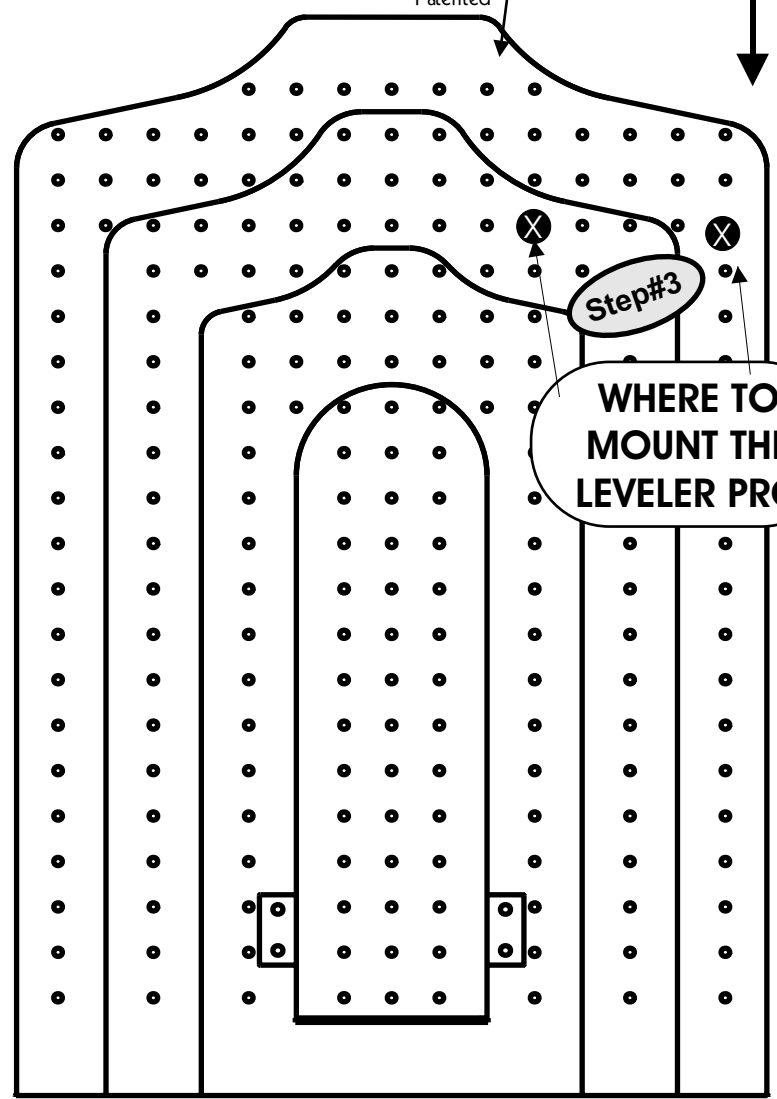
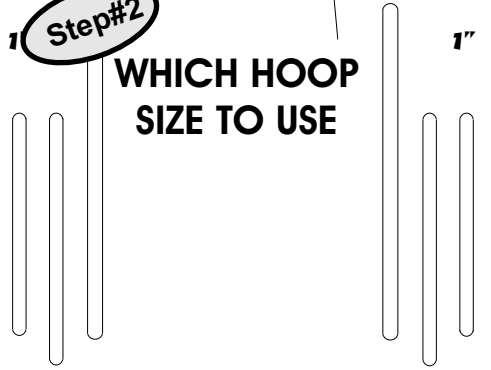

**Step#3**  
WHERE TO  
MOUNT THE  
LEVELER PRO

visit [tex-inc.com](http://tex-inc.com) for **FREE** Designs & **FREE** Digitizing Quote!

**ADULT**

# **JOB PLACEMENT CARD**

3 easy steps to repeating your orders

Type of Garment: HOODED SWEATSHIRT / WINDSHIRT PULLOVER

Embroidery Location: LEFT OR RIGHT CHEST PLACEMENT

Garment Size: Youth Adult SM-MED

Board Size Used: Sleeve - Infant - Youth - Adults - XL Adults

**ALL IN 1  
Leveler  
Pro**

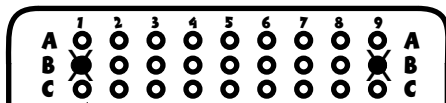

MOUNTING HOLES

Step#1

WHICH HOLE TO USE

4.7" 12cm

5.9" 15cm

7.1" 18cm

8.3" 21cm

Step#2

WHICH HOOP SIZE TO USE

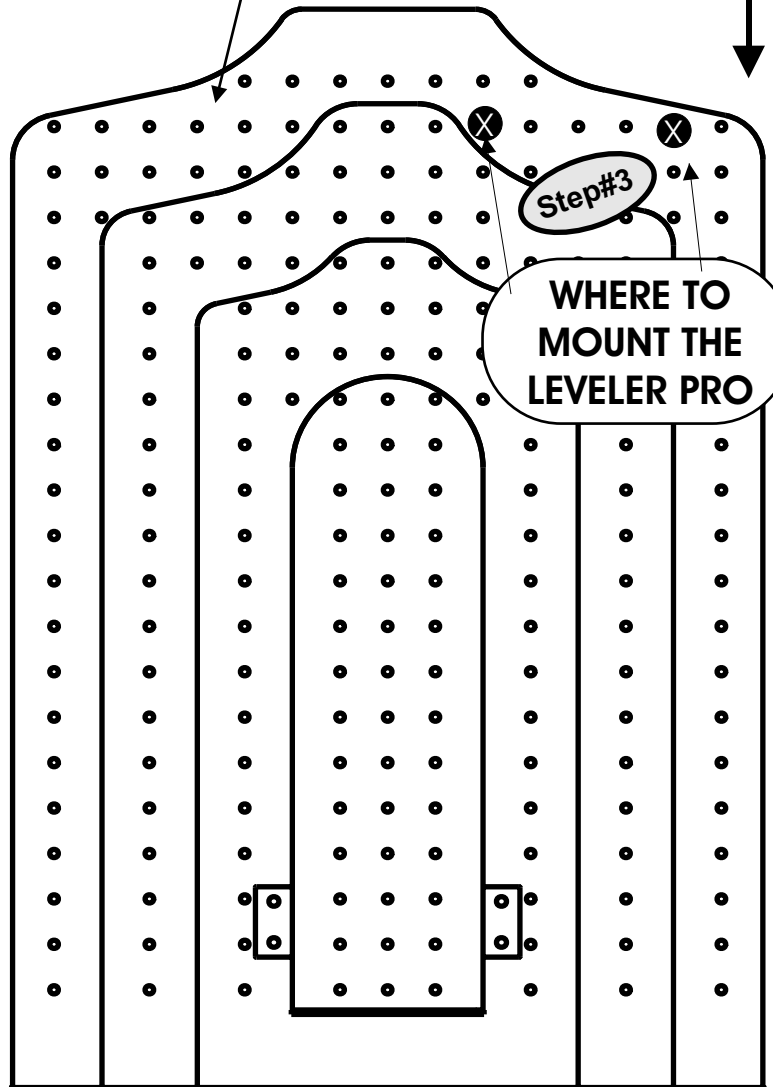
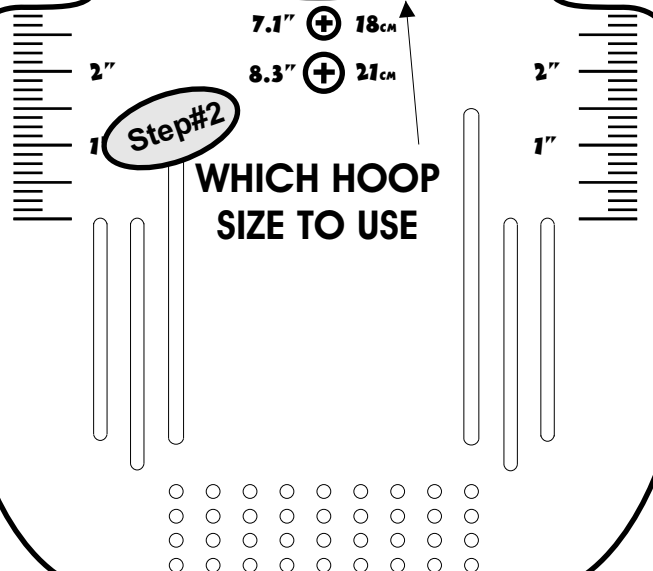

visit [tex-inc.com](http://tex-inc.com) for FREE Designs & FREE Digitizing Quote!

**ADULT**

# **JOB PLACEMENT CARD**

3 easy steps to repeating your orders

Type of Garment: HOODED SWEATSHIRT / WINDSHIRT PULLOVER

Embroidery Location: LEFT OR RIGHT CHEST PLACEMENT

Garment Size: Youth Adult LG-XLG

Board Size Used: Sleeve - Infant - Youth - Adults - XL Adults

**ALL IN 1  
Leveler  
Pro**

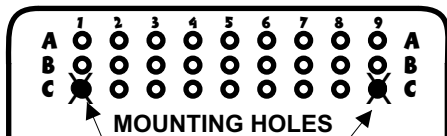

Step#1

**WHICH HOLE TO USE**

- 4.7" ⊕ 12cm
- 5.9" ⊕ 15cm
- 7.1" ⊕ 18cm
- 8.3" ⊕ 21cm

Step#2

**WHICH HOOP SIZE TO USE**

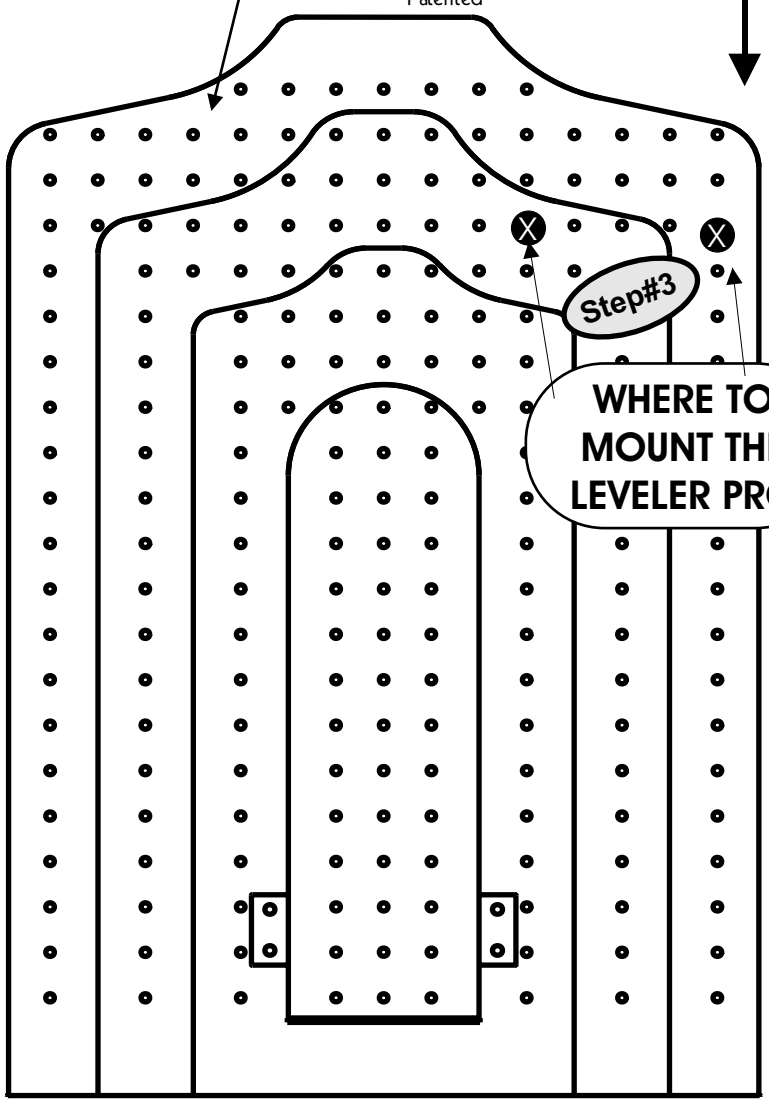
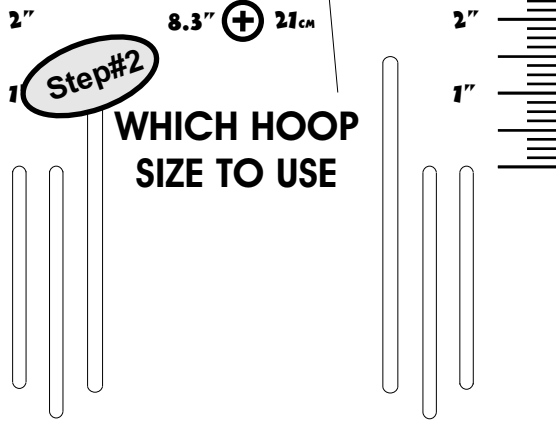

Step#3

**WHERE TO MOUNT THE LEVELER PRO**

visit [tex-inc.com](http://tex-inc.com) for **FREE** Designs & **FREE** Digitizing Quote!

**ADULT**

# **JOB PLACEMENT CARD**

3 easy steps to repeating your orders

Type of Garment: HOODED SWEATSHIRT / WINDSHIRT PULLOVER

Embroidery Location: LEFT OR RIGHT CHEST PLACEMENT

Garment Size: Youth Adult 2XL & UP

Board Size Used: Sleeve - Infant - Youth - Adults - XL Adults



Adult Board  
With Extension  
arms out

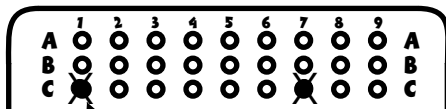

MOUNTING HOLES

Step#1

WHICH HOLE TO USE

4.7" 12cm

5.9" 15cm

7.1" 18cm

8.3" 21cm

Step#2

WHICH HOOP SIZE TO USE

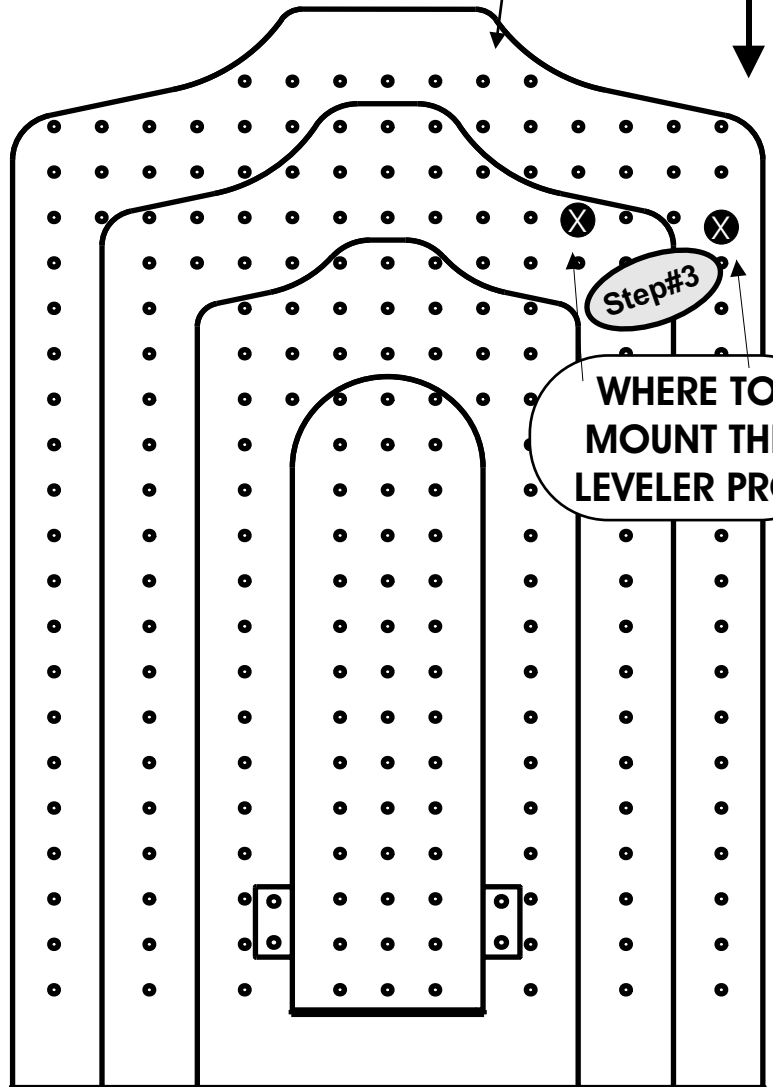
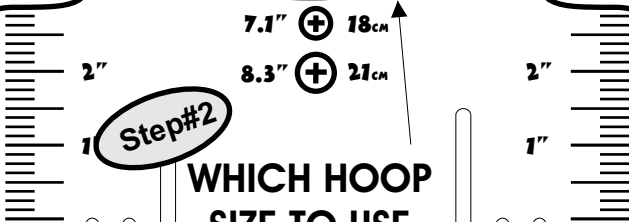

Step#3

WHERE TO MOUNT THE LEVELER PRO

visit [tex-inc.com](http://tex-inc.com) for FREE Designs & FREE Digitizing Quote!

**ADULT**

# **JOB PLACEMENT CARD**

3 easy steps to repeating your orders

Type of Garment: ADULT ALL SIZES / NECK LINE - YOKE AREA

Embroidery Location: BACK OF NECK-YOKE AREA PLACEMENT

Garment Size: Youth Adult ALL SIZES

Board Size Used: Sleeve - Infant - Youth - Adults - XL Adults

**ALL IN 1  
Leveler  
Pro**

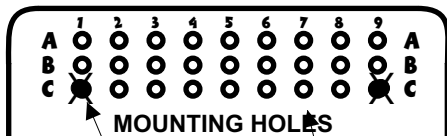

MOUNTING HOLES

Step#1

WHICH HOLE TO USE

4.7" 12cm

5.9" 15cm

7.1" 18cm

8.3" 21cm

Step#2

WHICH HOOP SIZE TO USE

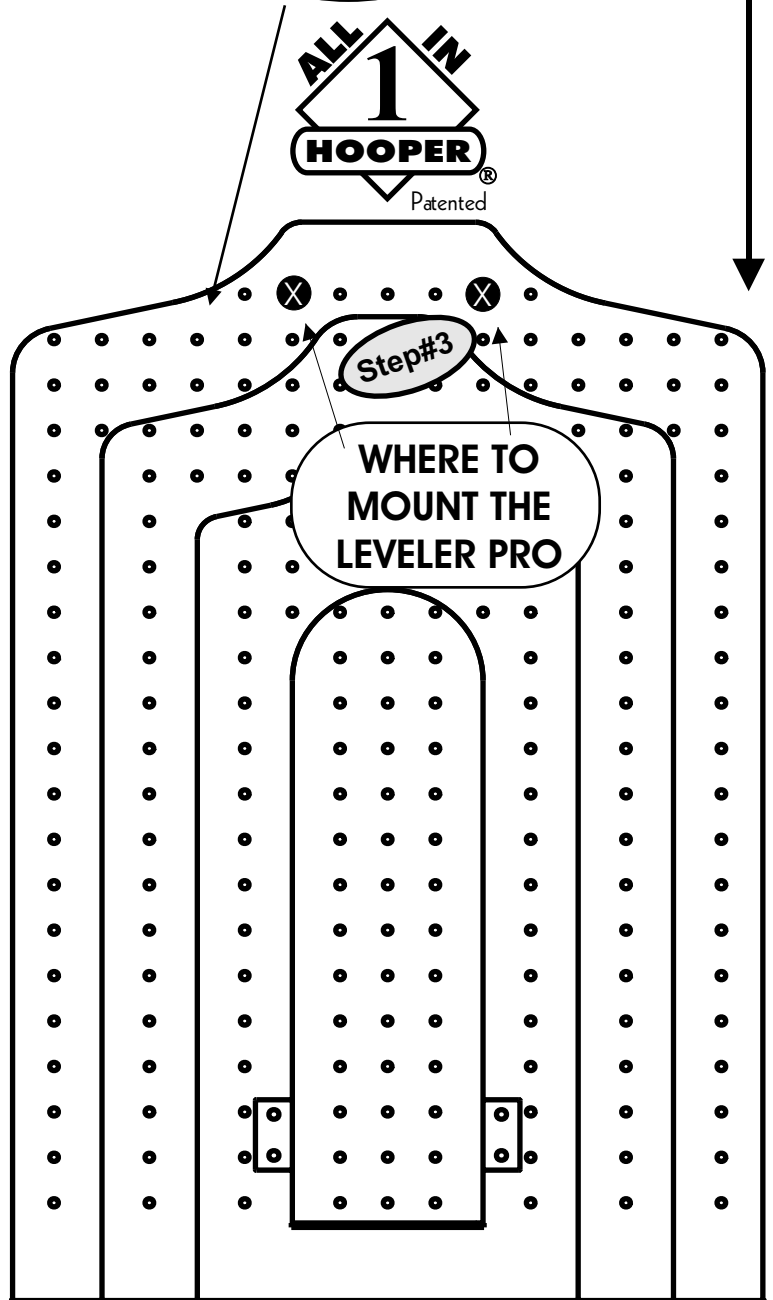
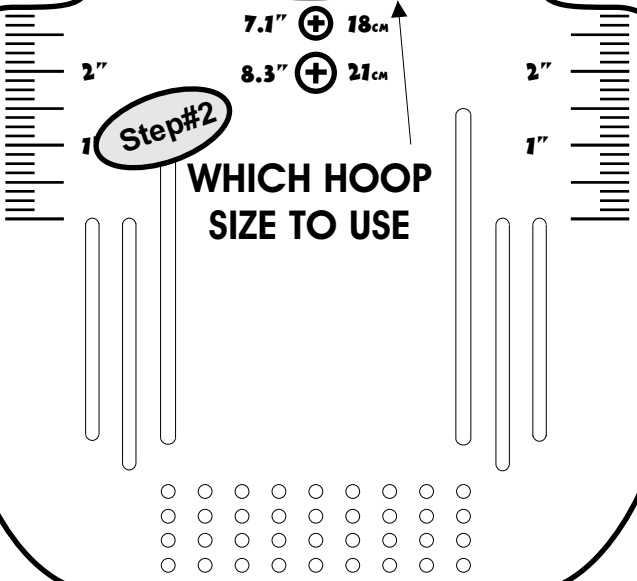

Step#3

WHERE TO MOUNT THE LEVELER PRO

visit [tex-inc.com](http://tex-inc.com) for **FREE** Designs & **FREE** Digitizing Quote!

**ADULT**

# **JOB PLACEMENT CARD**

3 easy steps to repeating your orders

Type of Garment: LADIES 4 BUTTON KNIT SPORT SHIRT

Embroidery Location: LEFT OR RIGHT CHEST PLACEMENT

Garment Size: Youth Adult SM-MED

Board Size Used: Sleeve - Infant - Youth - Adults - XL Adults

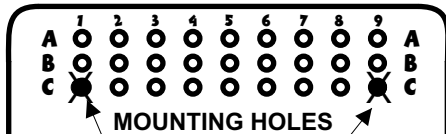

**Step#1**  
WHICH HOLE TO USE

- 4.7" ⊕ 12cm
- 5.9" ⊕ 15cm**
- 7.1" ⊕ 18cm
- 8.3" ⊕ 21cm

**Step#2**  
WHICH HOOP SIZE TO USE

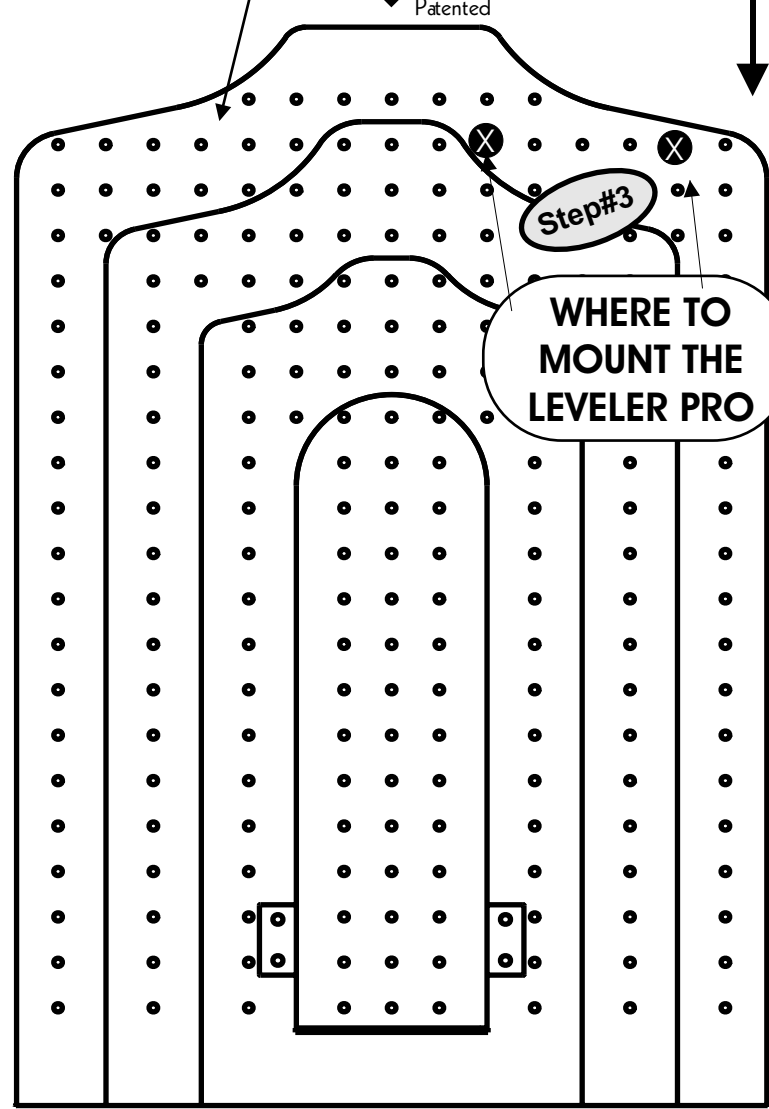

**Step#3**  
WHERE TO MOUNT THE LEVELER PRO

visit [tex-inc.com](http://tex-inc.com) for **FREE** Designs & **FREE** Digitizing Quote!

**ADULT**

# **JOB PLACEMENT CARD**

3 easy steps to repeating your orders

Type of Garment: LADIES 4 BUTTON KNIT SPORT SHIRT

Embroidery Location: LEFT OR RIGHT CHEST PLACEMENT

Garment Size: Youth Adult LG-XLG

Board Size Used: Sleeve - Infant - Youth - Adults - XL Adults

**ALL IN 1  
Leveler  
Pro**

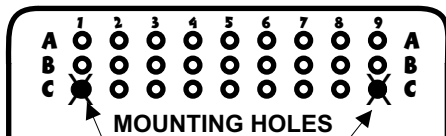

**Step#1**  
WHICH HOLE TO USE

- 4.7" 12cm
- 5.9" 15cm**
- 7.1" 18cm
- 8.3" 21cm

**Step#2**  
WHICH HOOP SIZE TO USE

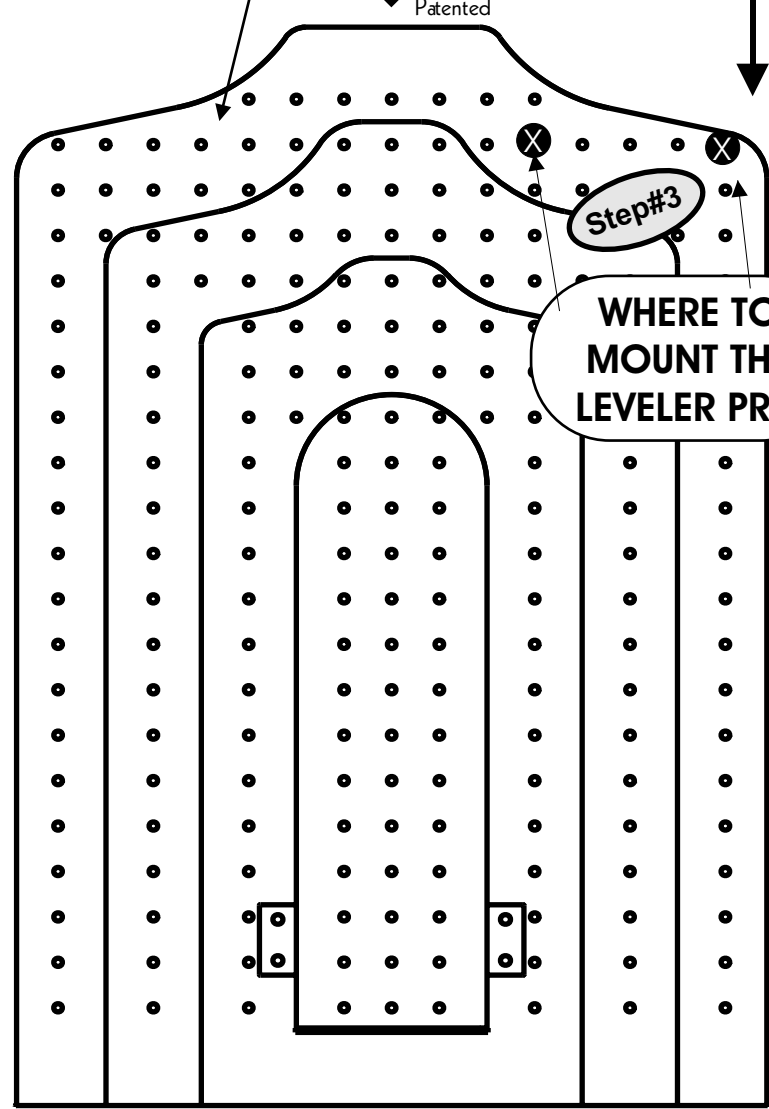

visit [tex-inc.com](http://tex-inc.com) for **FREE** Designs & **FREE** Digitizing Quote!

**ADULT**

# **JOB PLACEMENT CARD**

3 easy steps to repeating your orders

Type of Garment: LADIES KNIT SPORT SHIRT / DENIM & DRESS SHIRT

Embroidery Location: LEFT OR RIGHT CHEST PLACEMENT

Garment Size: Youth Adult SM-MED

Board Size Used: Sleeve - Infant - Youth - Adults - XL Adults

**ALL IN 1  
Leveler  
Pro**

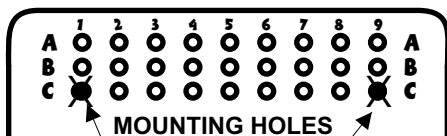

Step#1

**WHICH HOLE TO USE**

4.7" 12cm

5.9" 15cm

7.1" 18cm

8.3" 21cm

Step#2

**WHICH HOOP SIZE TO USE**

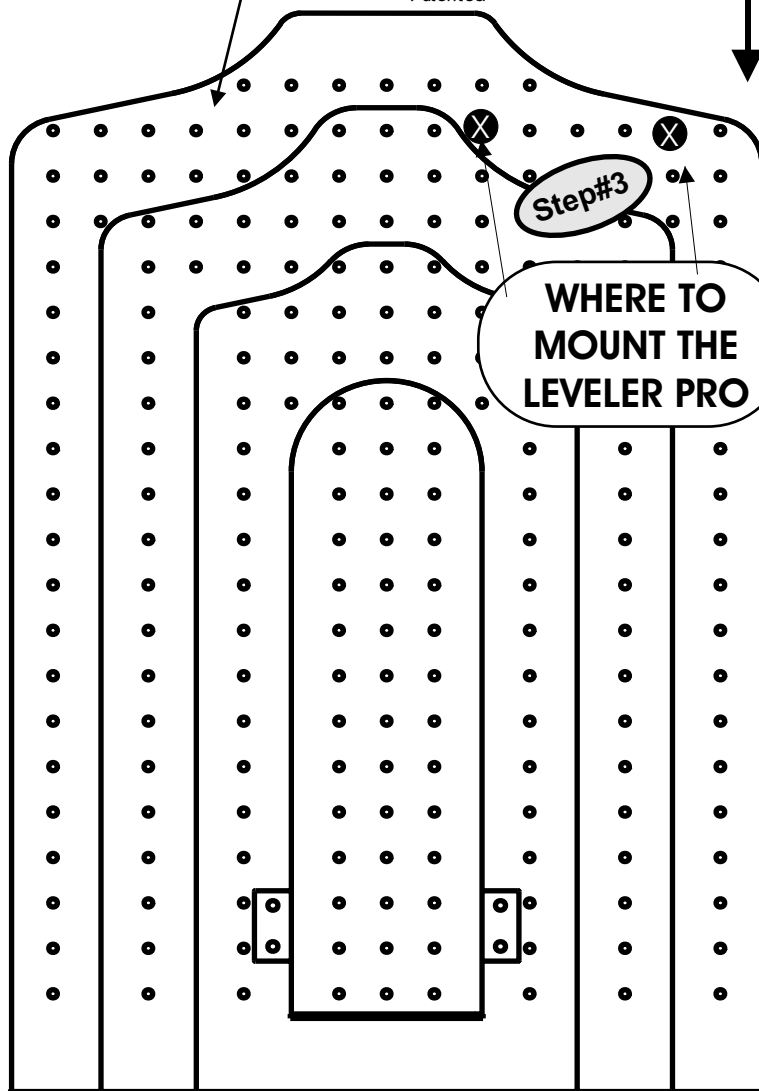
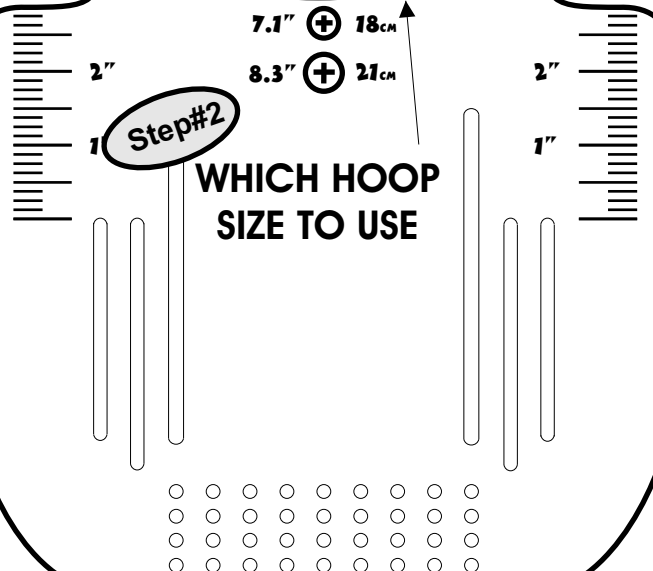

Step#3

**WHERE TO MOUNT THE LEVELER PRO**

visit [tex-inc.com](http://tex-inc.com) for **FREE** Designs & **FREE** Digitizing Quote!

**ADULT**

# **JOB PLACEMENT CARD**

3 easy steps to repeating your orders

Type of Garment: LADIES KNIT SPORT SHIRT / DENIM & DRESS SHIRT

Embroidery Location: LEFT OR RIGHT CHEST PLACEMENT

Garment Size: Youth Adult LG-XLG

Board Size Used: Sleeve - Infant - Youth - Adults - XL Adults

**ALL IN 1  
Leveler  
Pro**

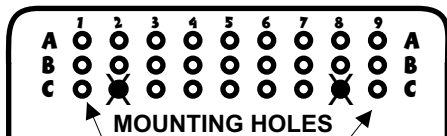

**Step#1**  
WHICH HOLE TO USE

4.7" 12cm

5.9" 15cm

7.1" 18cm

8.3" 21cm

**Step#2**

WHICH HOOP SIZE TO USE

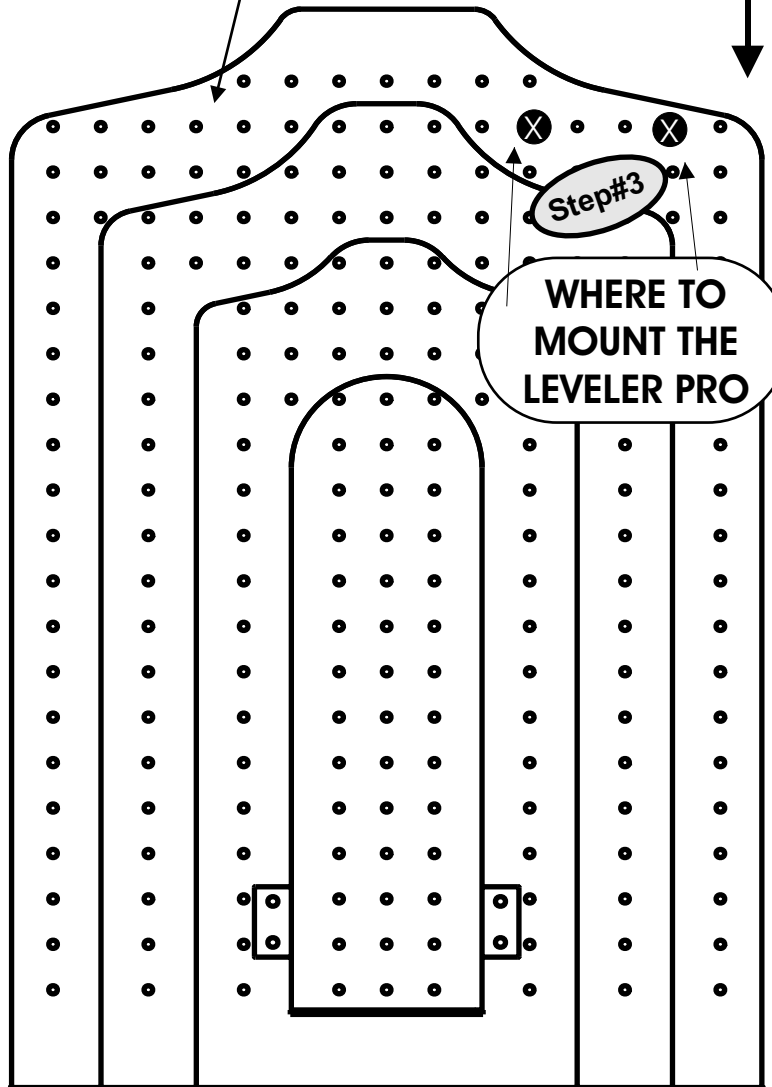

**Step#3**  
WHERE TO MOUNT THE LEVELER PRO

visit [tex-inc.com](http://tex-inc.com) for **FREE** Designs & **FREE** Digitizing Quote!

**ADULT**

# **JOB PLACEMENT CARD**

3 easy steps to repeating your orders

Type of Garment: 2 BUTTON HENLEY / BASEBALL HENLEY

Embroidery Location: LEFT OR RIGHT CHEST PLACEMENT

Garment Size: Youth Adult SM-MED

Board Size Used: Sleeve - Infant - Youth - Adults - XL Adults

**ALL IN 1  
Leveler  
Pro**

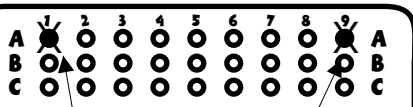

MOUNTING HOLES

**Step#1**  
WHICH HOLE TO USE

- 4.7" 12cm
- 5.9" 15cm**
- 7.1" 18cm
- 8.3" 21cm

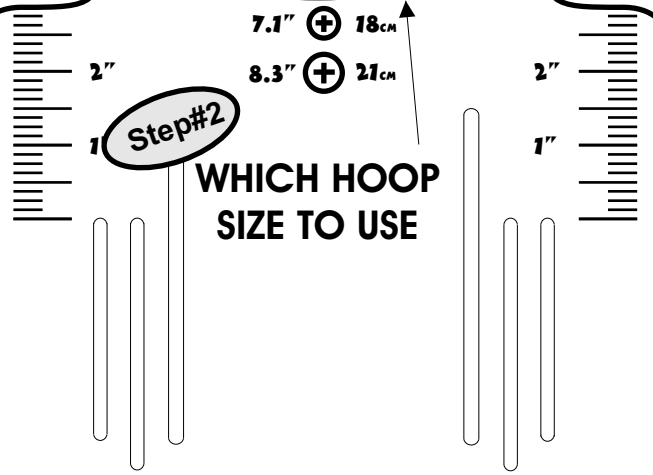

**Step#2**  
WHICH HOOP SIZE TO USE

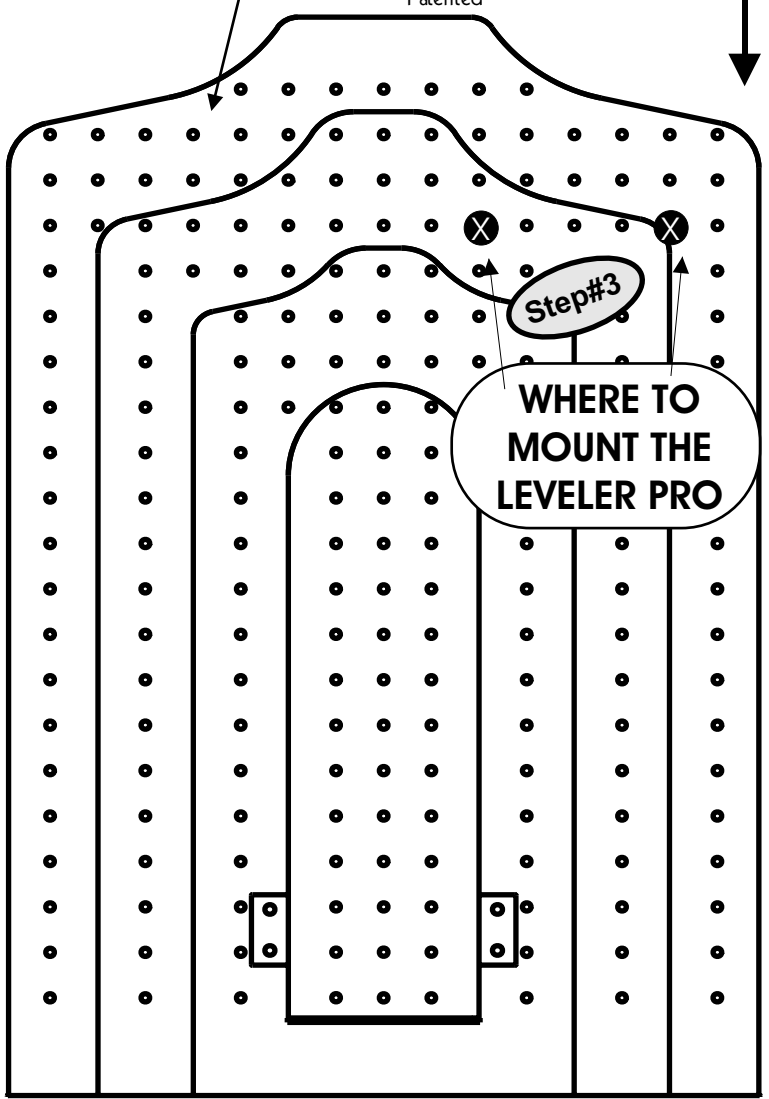

**Step#3**  
WHERE TO MOUNT THE LEVELER PRO

visit [tex-inc.com](http://tex-inc.com) for **FREE** Designs & **FREE** Digitizing Quote!

**ADULT**

# JOB PLACEMENT CARD

3 easy steps to repeating your orders

Type of Garment: 2 BUTTON HENLEY / BASEBALL HENLEY

Embroidery Location: LEFT OR RIGHT CHEST PLACEMENT

Garment Size: Youth Adult LG-XLG

Board Size Used: Sleeve - Infant - Youth - Adults - XL Adults

**ALL IN 1**  
*Leveler*  
**Pro**™

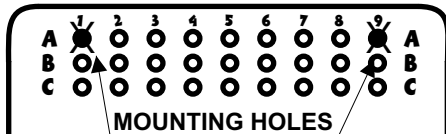

MOUNTING HOLES

**Step#1**  
WHICH HOLE TO USE

4.7" ⊕ 12cm

5.9" ⊕ 15cm

7.1" ⊕ 18cm

8.3" ⊕ 21cm

**Step#2**

WHICH HOOP SIZE TO USE

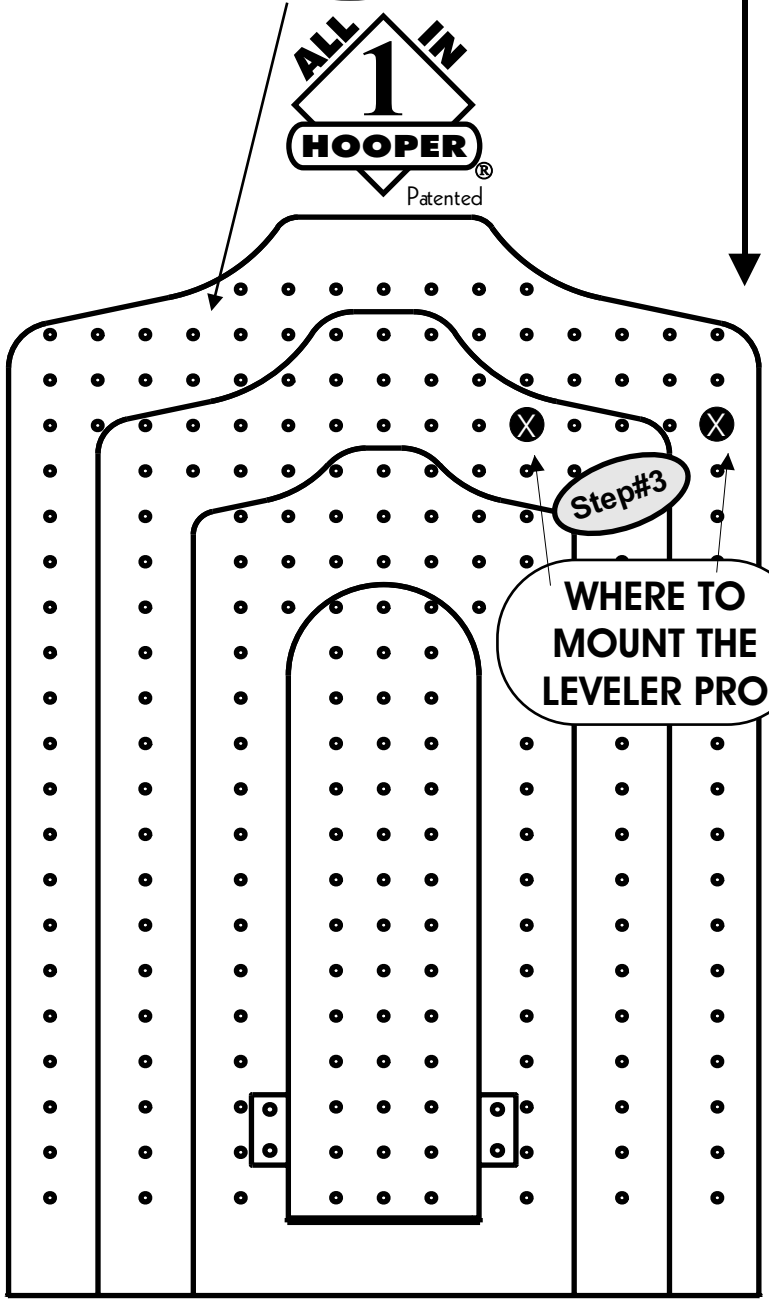
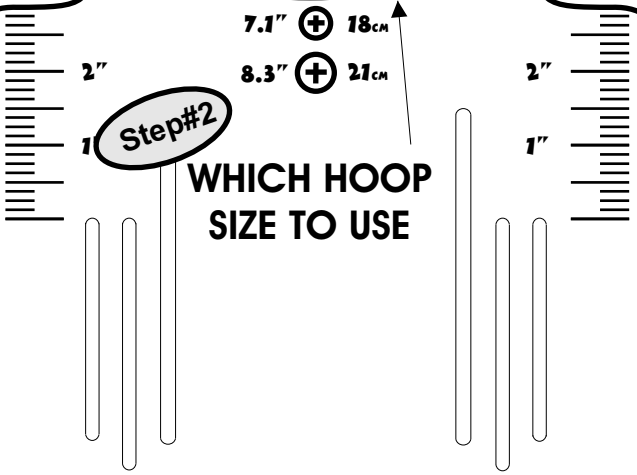

**Step#3**  
WHERE TO MOUNT THE LEVELER PRO

visit [tex-inc.com](http://tex-inc.com) for **FREE** Designs & **FREE** Digitizing Quote!

**ADULT**

# **JOB PLACEMENT CARD**

3 easy steps to repeating your orders

Type of Garment: 3 BUTTON HENLEY / BASEBALL HENLEY

Embroidery Location: LEFT OR RIGHT CHEST PLACEMENT

Garment Size: Youth Adult SM-MED

Board Size Used: Sleeve - Infant - Youth - Adults - XL Adults

**ALL IN 1  
Leveler  
Pro**

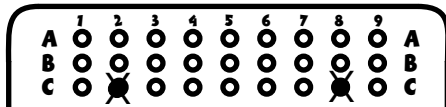

MOUNTING HOLES

**Step#1**  
WHICH HOLE TO USE

- 4.7" 12cm
- 5.9" 15cm**
- 7.1" 18cm
- 8.3" 21cm

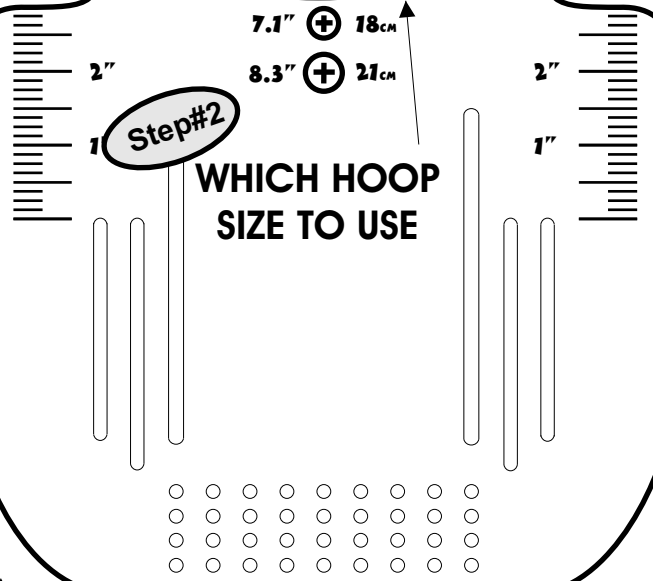

**Step#2**  
WHICH HOOP SIZE TO USE

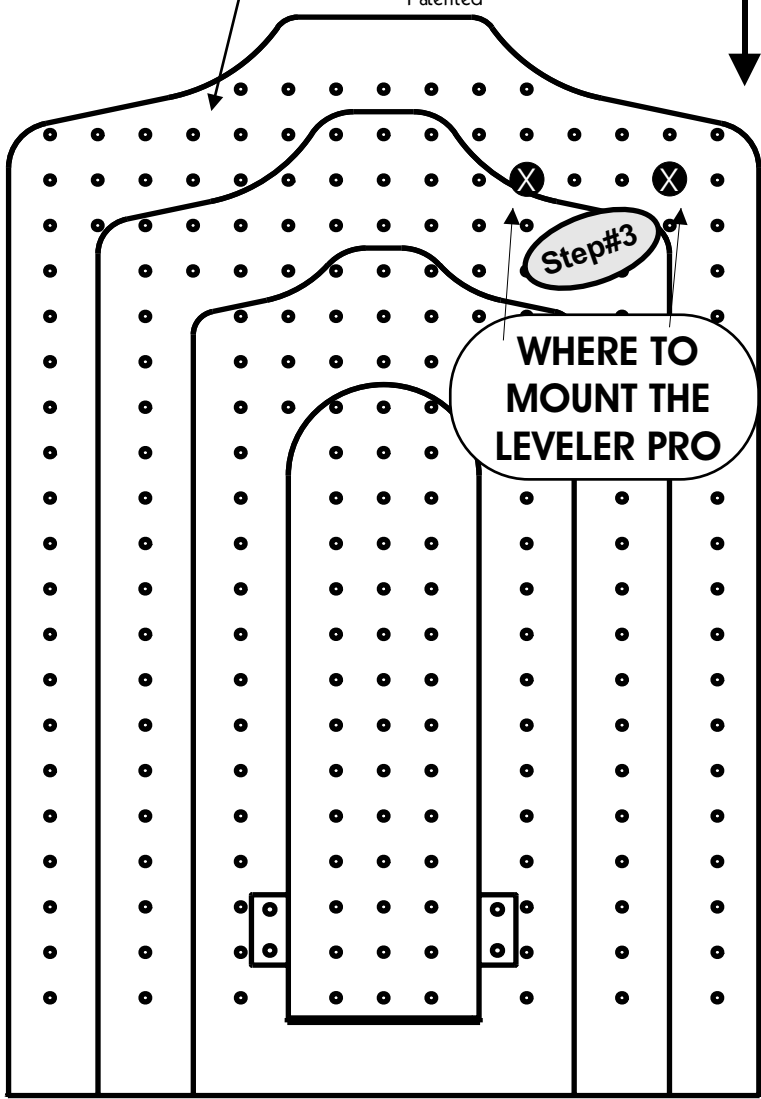

**Step#3**  
WHERE TO MOUNT THE LEVELER PRO

visit [tex-inc.com](http://tex-inc.com) for **FREE** Designs & **FREE** Digitizing Quote!

**ADULT** ←

# **JOB PLACEMENT CARD**

3 easy steps to repeating your orders

Type of Garment: 3 BUTTON HENLEY / BASEBALL HENLEY

Embroidery Location: LEFT OR RIGHT CHEST PLACEMENT

Garment Size: Youth Adult LG-XLG

Board Size Used: Sleeve - Infant - Youth - Adults - XL Adults

**ALL IN 1  
Leveler  
Pro**™

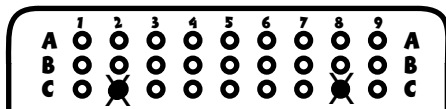

MOUNTING HOLES

Step#1

**WHICH HOLE TO USE**

4.7" ⊕ 12cm

5.9" ⊕ 15cm

7.1" ⊕ 18cm

8.3" ⊕ 21cm

Step#2

**WHICH HOOP SIZE TO USE**

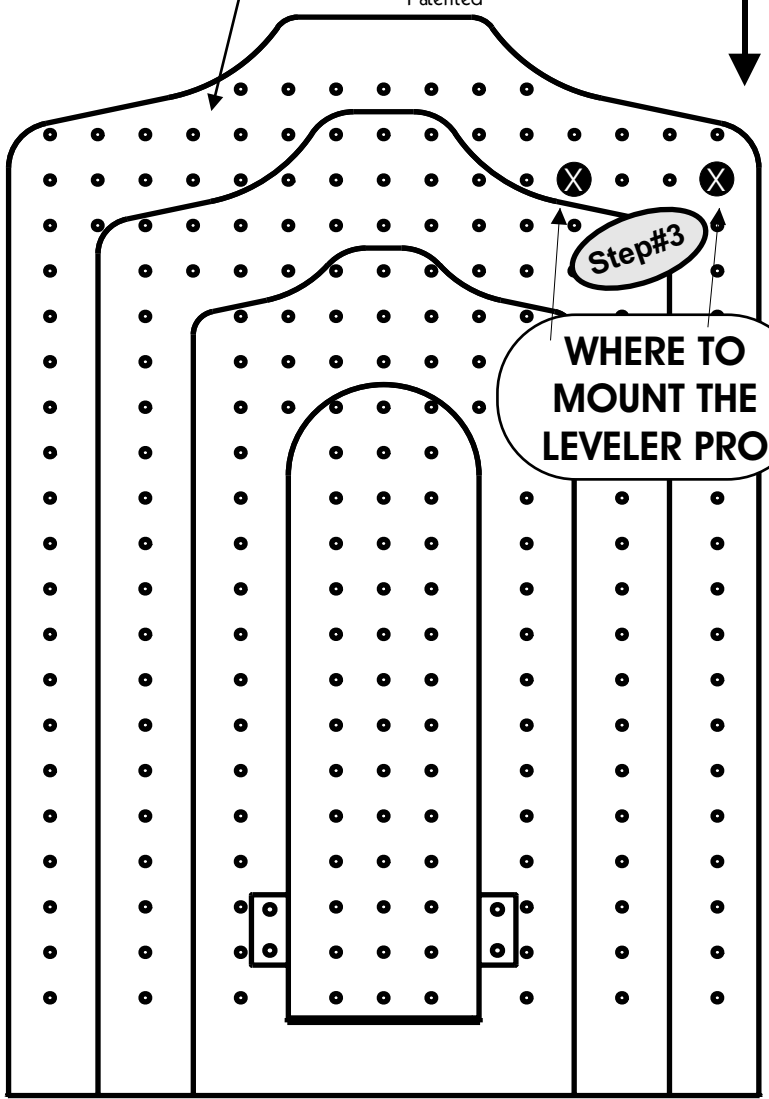
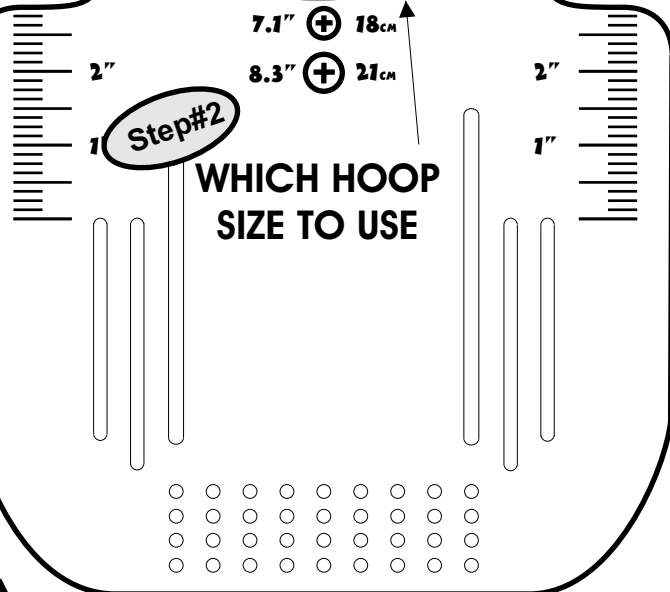

Step#3

**WHERE TO MOUNT THE LEVELER PRO**

visit [tex-inc.com](http://tex-inc.com) for **FREE** Designs & **FREE** Digitizing Quote!